

HE403C-GR Green Dot Sight User's Manual

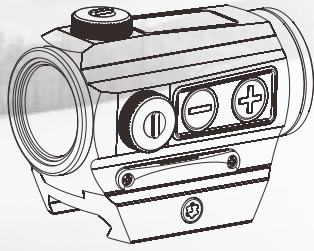

COLOR Desert Sand
 Matte Black

www.holosun.com

Thank you for purchasing the HE403C-GR Green Dot sight, which is a monocular inner green dot sight, please read the User's Manual carefully.

Model

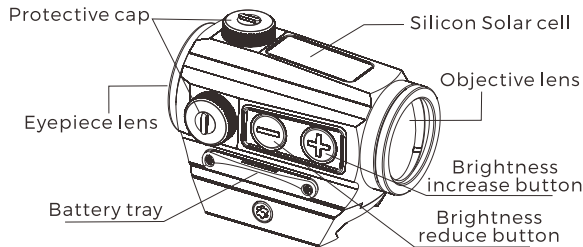

Fig1 HE403C-GR Green Dot Sight

.2.

Features

1. Advanced LED technology: Up to 50,000 hours
2. 2 MOA Dot
3. Dual power supply design: battery and Solar power supply
4. Parallax free, unlimited eye relief
5. Shake Awake™ - Motion on with last setting recall
6. 12 Brightness Settings: 10DL & 2NV
7. Memory Function for Brightness Setting
8. 1.63" Quick Detach Mount and low mount
9. Waterproof: Ip67
10. Battery Tray

.4.

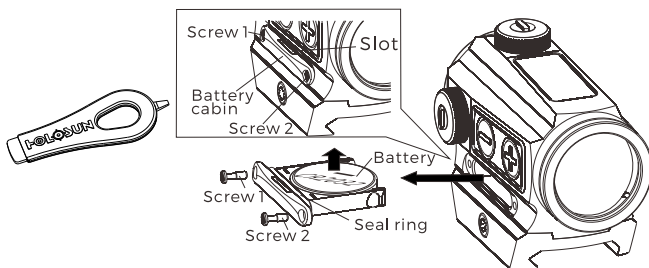

Fig 3-1

2) Battery installation(Fig3-2):

- a) Insert the battery into the battery tray making sure the "+" side faces down.

.6.

HE403C-GR

HE403C-GR: New small compact is a green dot sight. Employing new LED technology, the life time for one CR2032 battery can be up to 50,000 hours. The device operates by solar power (silicon solar cell). The sight may be installed on various firearms such as shotguns, pistols, rifles, air rifles and crossbows.

Important Notices

1. Ensure that the firearm is completely unloaded and safe before device installation, sighting in, or installing a new Battery.
2. Please keep the packaging should you need to make a warranty claim.

.1.

Objective Lens

All micro sights have an objective lens at the front of the unit that is positioned off axis and appears to be tilted when looking at the sight.

This angle of the front lens allows the light generated by the LED projector inside the unit to be reflected back through the rear lens. The reflected light becomes the "dot" or aiming reference that the user sees when a green dot sight is switched on.

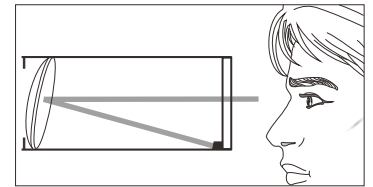

Fig2

.3.

Battery

1. Operates with two-way power supply (solar cell and internal battery). one high quality CR2032 Lithium battery is included with purchase.
2. The high quality battery can power the device for up to 50,000 hours.

Caution: The battery is not rechargeable.

3. Battery replacement:

1) Remove the battery (Fig 3-1):

- a) Loosen screws 1,2.
- b) Insert the included teardrop shaped tool in the battery tray slot, pry out the tray, and remove the dead battery.

.5.

b) Insert and press the tray into the battery compartment.

c) Tighten screw 1,2.

Caution:

The loss or damage of the seal ring may cause water to leak into the compartment which could damage the product.

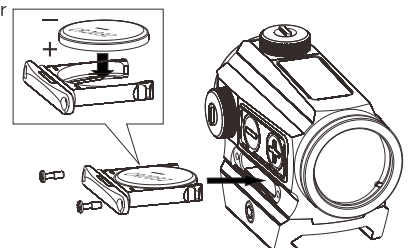

Fig 3-2

.7.

Installation

1. The mounting bracket is adaptable to any firearm with a Picatinny or Weaver Rail. If the firearm has no compatible rail, contact a qualified gunsmith.
2. Insert the appropriate Torx wrench (included) into the clamp bolt head, rotate to loosen the cross bolt and then slide the sight into the firearm rail to the appropriate position. Finally tighten the clamp bolt. (Fig4)

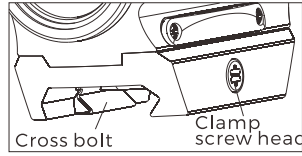

Fig 4

.8.

Auto mode operation:

- a) Under auto mode, the brightness of the dot is automatically adjusted to match ambient lighting.
 - b) The battery will compensate for power if the solar cell cannot drive the dot alone.
 - c) If lighting insufficient, the sight will automatically switch to battery power. While running on battery, you can adjust the reticle brightness using the "+" and "-" buttons to switch between high, medium and low brightness levels.
- 2) Manual mode:
- a) Depress the "+" button and hold it down until the dot blinks once. This will cycle between auto and manual mode.
 - b) Brightness adjustment: There are 12 settings for dot brightness level under manual mode. Using "+" or "-" to increase or decrease the

.10.

The LED will blink (1=10 min, 2=1h, 3=12h, or 4=disable sleep mode).

- iii. Press the "+" and "-" buttons simultaneously to save the time setting and power off the sight.

5. Note:

- 1) Memory function: The sight will remember the last saved brightness setting when powered on and off.
- 2) Low battery Warning: If the battery voltage is below 2.2Vdc, the reticle will blink slowly.

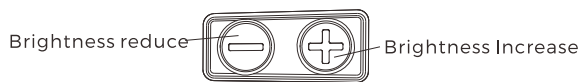

Fig 5

.12.

4. Right turning the elevation knob will moving the green dot up, left turning will lower the green dot. Similar for the windage adjusting, right turning will move the green dot to right, left turning will move it to left.

5. Caution:

Don't try to rotate the knobs, if you feel the knobs cannot be rotated which proves the adjustment limits. Otherwise the device may be damaged. If the adjusting range is beyond the limits, consider to add extra spacer between the device and mount rail to expand the adjusting range limits.

.14.

Sight operation

Two operation modes are available: Auto mode and manual mode.

1. Switch on (see Fig5): Press and release either brightness button ("+" or "-") to turn on the sight.
2. Power off: Press the "+" and "-" buttons simultaneously to turn the power and motion sensor off.
3. Operations: Two operation modes are available: Auto mode and manual mode.
 - 1) Auto mode - operates with solar cell and internal battery two-way power supply: Based upon the ambient lighting level, the sight will switch between battery and solar cell power automatically. Accommodates operation in all lighting conditions.

.9.

brightness.

- c) Switching back to auto mode: Hold down the "+" button for 3 seconds will switch the sight to auto mode and remember the setting.

4. Sleep time mode:

- 1) Please note that your green dot will automatically enter into sleep mode after 10 minutes of no movement.
- 2) The sight will instantaneously wake up and turn on with any motion detection to last saved setting.
- 3) The default sleep timer setting is 10 min, but can be adjusted.
 - i. Press and hold the "+" button for 10 seconds to enter time adjustment mode. There are 4 options: 10 min, 1h, 12h or the sleep mode is disabled.
 - ii. Press and release either "+" or "-" button to set the time.

.11.

Zero setting

1. On top of sight is the elevation adjusting knob, windage adjusting knob is on the right side (see Fig6). The sight has been primarily adjusted in factory.
2. The Convex platform on the protective cap can be used for zeroing alignment (see Fig6).
3. First open the protective lid, position slot type screwdriver on the slotted screw, then rotate the screw to right or left for adjustment. Each left or right click is for one shift moving equivalent to 0.5 MOA value.

.13.

Note:

- 1) Direction adjusting marks are inside the protective cap.
- 2) The adjusting screw under the protective cap is waterproof.

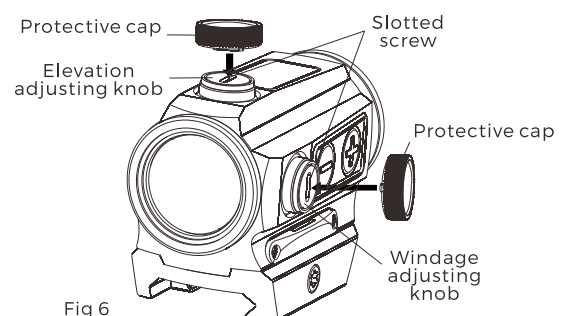

Fig 6

.15.

Maintenance & care

This device is a precision instrument that deserves reasonably cautious care. The following tips are provided to ensure a long product life. The optical lenses are multicoated optical glass. When cleaning the lenses, blow away the dust on the surface, wet the lens with lens cleaner or clean water, then wipe away smudges with lens tissue, soft cotton or a microfiber cloth. Avoid touching the glass surface with dry cloth or tissue paper. Do not use organic solvents such as alcohol or acetone. No special maintenance is needed for the housing surface. Do not try to dismantle the device as the internal parts are specially cleaned and sealed and with an anti-fog treatment. Any such attempt will void the warranty.

.16.

Limited warranty

We provide a limited lifetime warranty from the date of purchase on parts and workmanship to the original purchaser. At our sole discretion, we will repair or replace products found to be defective under normal use without charge, excluding any delivery costs, which will be born by purchaser. We will not be liable for incidental, consequential, or special damages arising out of or in any connection with the use or performance of this product. This warranty is void if the product has been misused, modified, neglected, or disassembled prior to its return. Please refer to <http://holosun.com/documentation/> for current and complete warranty information and other conditions.

.17.



HOLOSUN®



Holosun Technologies Inc.
Customer Service

Phone: 909-594-2888
Email: warranty@holosun.com

V1.3