

HE503R-GD

HOLOSUN

Circle Dot Sight

User's Manual

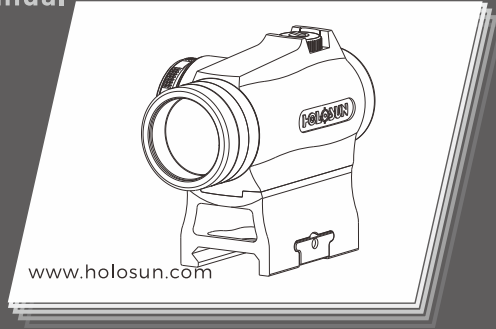

Thank you for purchasing the HE503R-GD Micro Sight with Circle-Dot reticle. Before operation please read the User Manual carefully.

Model

HE503R-GD

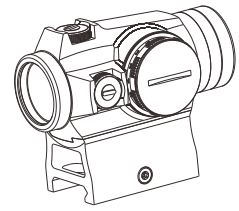

Fig1 HS503R Micro Sight

Important Notices

1. Ensure that the firearm is completely unloaded and safe before device installation, or installing a new battery.
2. Please keep the packaging should you need to make a warranty claim.

Features

- 1) Up to 100,000 hour battery life .
- 2) 2 Reticle Options: 65 MOA circle with 2 MOA dot ; 2MOA dot only.
- 3) Parallax free, unlimited eye relief.
- 4) 10 daylight and 2 night vision compatible reticle brightness settings.
- 5) CNC milled 6061 aluminum housing and mount.
- 6) Protective shrouds on windage and elevation turrets.
- 7) Includes a 1.63" Absolute Co-witness mount and low mount.
- 8) Waterproof: IP67

2. A high quality battery can power this 2MOA Dot optic for up to 100,000 hours using the 2MOA dot on setting 6.

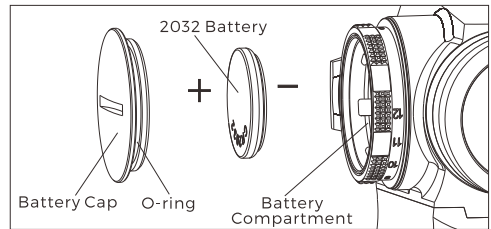

Fig3

Caution: Do not use a rechargeable battery.

3. Please see Fig 3 for battery installation and replacement:
 - 1) Remove the battery cap by rotating counterclockwise.
 - 2) Remove the old battery if applicable. Install a new battery with the POSITIVE side facing outward (Fig.3).
 - 3) Replace the battery cap by rotating clockwise.

Caution:

Removal or damage to the O-ring inside the battery cap will cause moisture ingress which may damage the electrical circuits and device.

Objective Lens

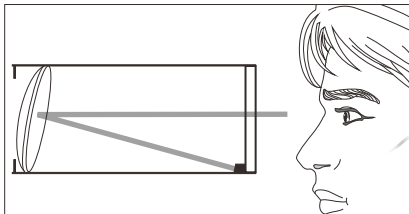

Fig2

Reflex sights have an objective lens that is positioned at an angle in order to properly reflect the reticle/dot. The objective lens must be perpendicular to the LED which projects the light that is reflected off of the front lens and produces the reticle/dot you see.

Multi Reticle

The reticle for this sight is a central 2MOA dot, centered in a 65MOA circle with four positioning points. The diameter of the circle reticle represents approximately 5' 5" at 100 yards(170cm at 100m).



Installation

1. The included mount is designed for use with a 1913 Picatinny rail only.
2. To install the optic, loosen the T10 crossbolt with the supplied T10 Torx tool. Attach the optic onto the Picatinny rail in a suitable location. Push the optic forward towards the muzzle and tighten.(Fig4)

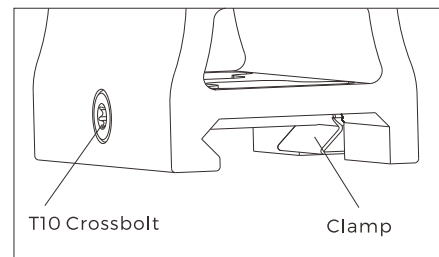

Fig 4

Battery

1. The operating voltage for this device is DC3V using one high quality CR2032 Lithium battery which is included.

Sight Operation

The brightness settings are adjusted using the rotary switch that is integrated with the battery compartment (see Fig5). The HE503R-GD has a total of 12 brightness settings. To select a adjusting, you only need to setting, align the brightness setting number with the "△" symbol on the See Fig. 6 for rotary switch settings.body.

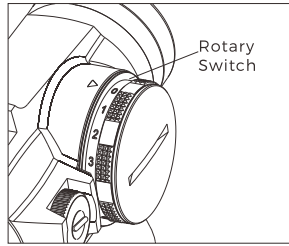

Fig 5

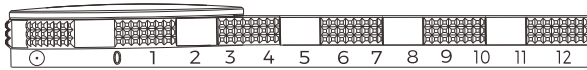

Fig 6

- 1.Power OFF: The "0" setting will power the optic OFF.
2. Reticle Brightness Adjustment
Settings 1 and 2 are night vision compatible settings for use with night vision devices.
Settings 3 - 12 are daylight visible settings. Reticle brightness will increase as the setting number increases.
- 3.Reticle Selection
The HE503R-GD features the circle-dot Multi Reticle System. The default setting is a 2MOA dot only. Selecting the "⊙" setting will switch between the dot only and the circle-dot reticle. Selecting the "⊙" again will change the reticle from the circle-dot back to the 2MOA dot only.

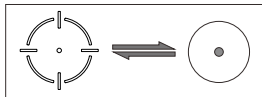

Fig 7

Zero Setting

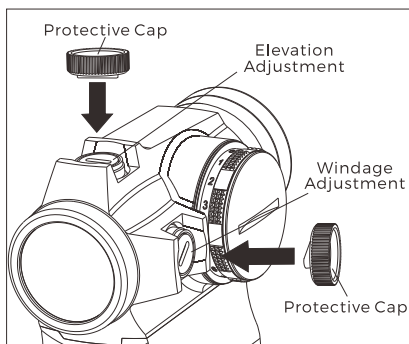

Fig 7

1. The elevation adjustment turret is on the top, the windage adjustment turret is on the right side (see Fig7). The sight has been factory adjusted for approximate zero at 25 yards.
2. The built in screwdriver tool on the protective cap can be used for zeroing adjustment (see Fig7). See label inside cap.
3. First remove the protective cap, then position the slot type driver into the adjustment turret slot. Rotate counterclockwise or clockwise to adjust point of impact. Each click has an adjustment value 0.5 MOA.
4. Adjust the Elevation turret counterclockwise to move the

point of impact UP. Adjust the Windage turret counter- clockwise to move the point of impact to the RIGHT. Turning either turret clockwise moves the point of impact in the opposite direction.

5. Caution:

Do not try to over rotate the turrets. If you feel the turrets can not be rotated, this indicates you have reached the adjustment limit, otherwise the device may be damaged. If the required adjusting range is beyond the limits, consider adding an extra spacer between the device and mounting rail to allow for additional adjustment.

Maintenance & care

This device is a precision instrument that deserves reasonably cautious care. The following tips are provided to ensure long lasting use of the sight.

The optical system includes the objective lens and ocular lens which are multi - coated optical glass. When cleaning the lenses, blow away any dust on the surface, wet the lens with lens cleaner or clean water, wipe fingerprints and oil stains with a lens tissue, soft cotton, or microfiber cloth. No special maintenance is needed for housing surface. Avoid touching the glass surface with a dry cloth or tissue paper . No organic solvents such as alcohol, acetone should be used. Do not try to dismantle the device as the internal parts are specially cleaned and sealed and with anti - fog treatment. Any such attempt will void the warranty.

If repair is needed, please call our customer service center, visit our website, or send us an email.

Limited warranty

SUMMARY

We provide a limited lifetime warranty from the date of purchase on parts and workmanship to the original purchaser. At our sole discretion, we will repair or replace products found to be defective under normal use and service it, without charge excluding any delivery costs, which will be born by purchaser. We will not be liable for incidental, consequential, or special damages arising out of or in any connection with the use or performance of this product. This warranty is void if the product has been misused, modified, neglected, or disassembled prior to its return.

Please refer to www.holosun.com for current and complete warranty information.

HE503R-GD
Circle Dot sight

HOLOSUN
Holosun Technologies Inc.
www.holosun.com

Customer Service

Phone: (909) 594-2888
Fax: (909) 598-4888
Email: warranty@holosun.com